

Data Sheet



Article number: 20605022

Description: E+G Ball transfer unit
GN 509-22-SNI

Measures

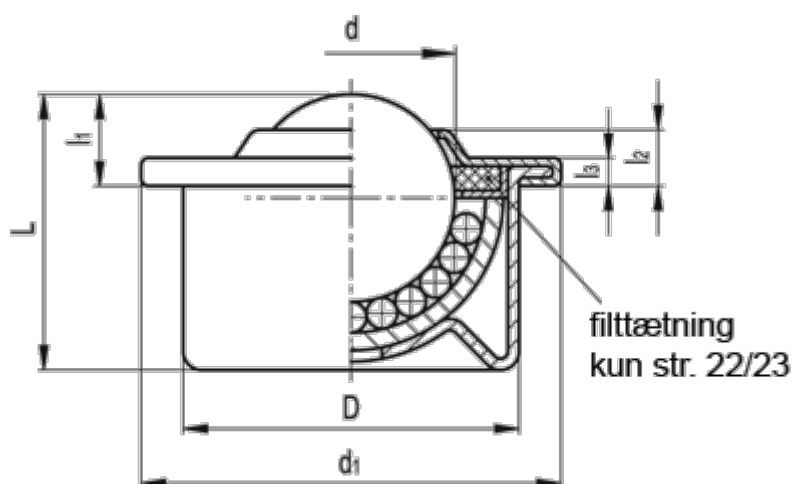

d	= 22.2
D	= 36
d1	= 45
L +/-0.3	= 29.5
l1 +/-0,3	= 10.0
l2 +/-0.3	= 6
l3	= 3.0
Max load (N)	= 900

Weight (g) = 130